

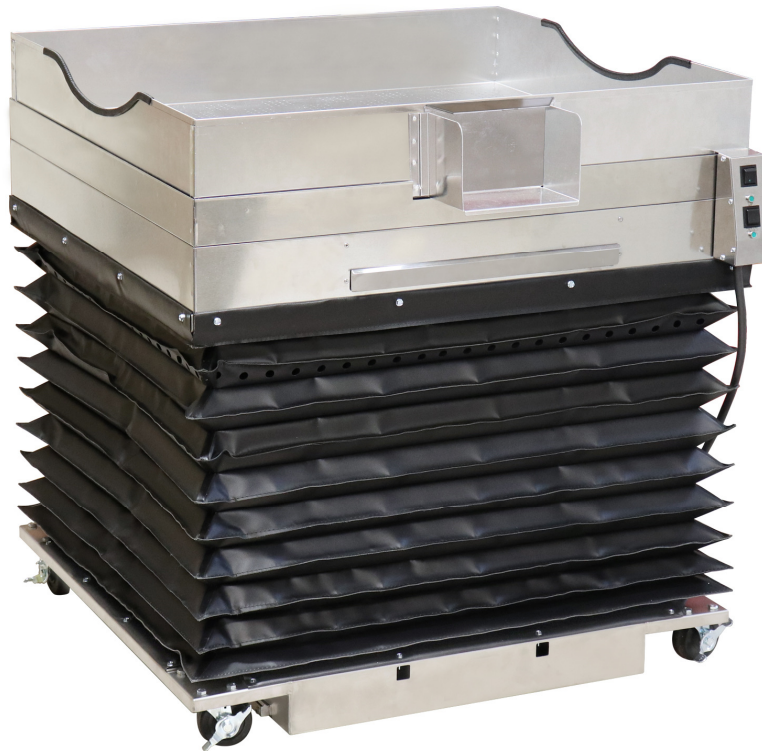

# Instruction Manual

## Karmel Kool Table

Model No. 2169-00-100



**GOLD MEDAL<sup>®</sup> PRODUCTS CO.**

10700 Medallion Drive, Cincinnati, Ohio 45241-4807 USA







# Table of Contents



<b>SAFETY PRECAUTIONS</b> .....	<b>3</b>
<b>INSTALLATION INSTRUCTIONS</b> .....	<b>5</b>
Inspection of Shipment .....	5
Manual.....	5
Model Description .....	5
Items Included with this Unit.....	5
Setup .....	6
Electrical Requirements .....	7
Before You Plug In Machine.....	7
<b>OPERATING INSTRUCTIONS</b> .....	<b>8</b>
Controls and Their Functions .....	8
Operating Instructions .....	8
<b>Care and Cleaning</b> .....	<b>9</b>
Filter Cleaning Instructions .....	9
<b>MAINTENANCE INSTRUCTIONS</b> .....	<b>10</b>
<b>Safety Stop Bracket</b> .....	<b>11</b>
<b>Control Pendant Orientation</b> .....	<b>12</b>
<b>ORDERING SPARE PARTS</b> .....	<b>13</b>
Unit Exterior – Parts Breakdown .....	14
Unit Interior – Parts Breakdown.....	16
<b>Wiring Diagram</b> .....	<b>18</b>
<b>WARRANTY</b> .....	<b>19</b>





# SAFETY PRECAUTIONS



	 <b>DANGER</b>
	<p>Machine must be properly grounded to prevent electrical shock to personnel. Failure to do so could result in serious injury, or death.                  DO NOT immerse any part of this equipment in water.                  DO NOT use excessive water when cleaning.                  Keep cord and plug off the ground and away from moisture.                  Always unplug the equipment before cleaning or servicing.                  Make sure all machine switches are in the OFF position before plugging the equipment into the receptacle.</p> <p style="text-align: right; font-size: small;">008_051514</p>

	 <b>DANGER</b>
	<p>Improper installation, adjustment, alteration, service, or maintenance can cause property damage, injury, or death. Any alterations to this equipment will void the warranty and may cause a dangerous condition. This appliance is not intended to be operated by means of an external timer or separate remote-control system. NEVER make alterations to this equipment. Read the Installation, Operating, and Maintenance Instructions thoroughly before installing, servicing, or operating this equipment.</p> <p style="text-align: right; font-size: small;">014_020416</p>

	 <b>WARNING</b>
	<p>ALWAYS wear safety glasses when servicing this equipment.</p> <p style="text-align: right; font-size: small;">010_010914</p>

	 <b>WARNING</b>
	<p>No user serviceable parts inside. Refer servicing to qualified service personnel.</p> <p style="text-align: right; font-size: small;">011_051514</p>

	 <b>WARNING</b>
	<p>Read and understand operator's manual and all other safety instructions before using this equipment. To order copies of the operator's manual go to <a href="http://gmpopcorn.com">gmpopcorn.com</a> or write to Gold Medal Products Co., 10700 Medallion Drive, Cincinnati, OH 45241 USA 1-(800)-543-0862</p> <p style="text-align: right; font-size: small;">022_060215</p>

	 <b>WARNING</b>
	<p>DO NOT allow direct contact of this equipment by the public when used in food service locations. Only personnel trained and experienced in the equipment operation may operate this equipment. Carefully read all instructions before operation.</p> <p style="text-align: right; font-size: small;">012_010914</p>



A red circle with a diagonal slash over a black hand icon, indicating that the machine should not be operated by minors.	<b>⚠ WARNING</b>
This machine is NOT to be operated by minors.	
007_010914	

**Note:** Improvements are always being made to Gold Medal's equipment. This information may not be the latest available for your purposes. It is critical that you call Gold Medal's Technical Service Department at 1-800-543-0862 for any questions about your machine operations, replacement parts, or any service questions. (Gold Medal Products Co. does not assume any liability for injury due to careless handling and/or reckless operation of this equipment.) General images may be used in manual for reference only.

# INSTALLATION INSTRUCTIONS

## Inspection of Shipment

After unpacking, check thoroughly for any damage which may have occurred in transit. Claims should be filed immediately with the transportation company. The warranty does not cover damage that occurs in transit, or damage caused by abuse, or consequential damage due to the operation of this machine, since it is beyond our control (reference warranty in back of manual).

## Manual

Read and understand the operator's manual and all other safety instructions before using this equipment. To order copies of the operator's manual go to [gmpopcorn.com](http://gmpopcorn.com) or write to Gold Medal Products Co., 10700 Medallion Drive, Cincinnati, OH 45241 USA 1-(800)-543-0862.

## Model Description

**2169-00-100:** Karmel Kool Table – Adjustable height from 20" to 36".

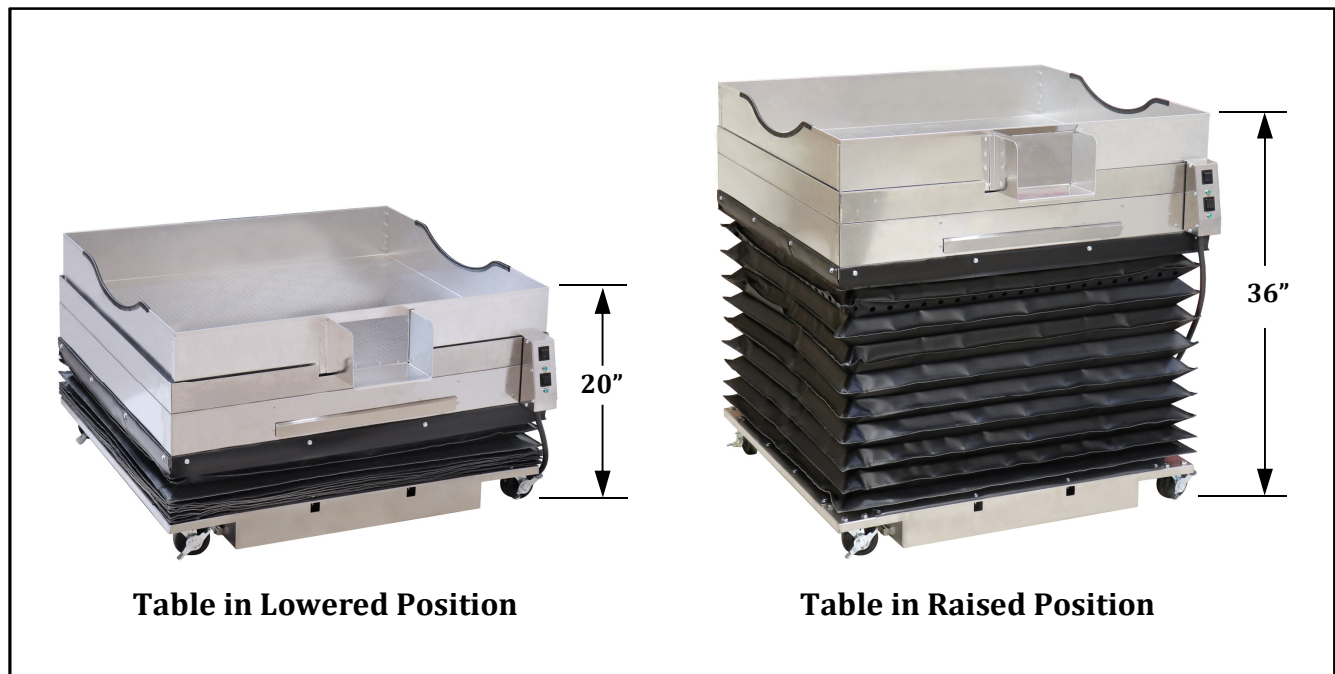

## Items Included with this Unit

- Manual and Registration/Warranty Card
- Pendant Hanging Bracket (PN 101442) to hold hand control, if needed.



## Setup

This unit has been tested at the factory. The table is designed for use with one Gold Medal 5 gallon or 10 gallon Corn Treat Mixer. Follow instructions below for table setup (reference images shown).

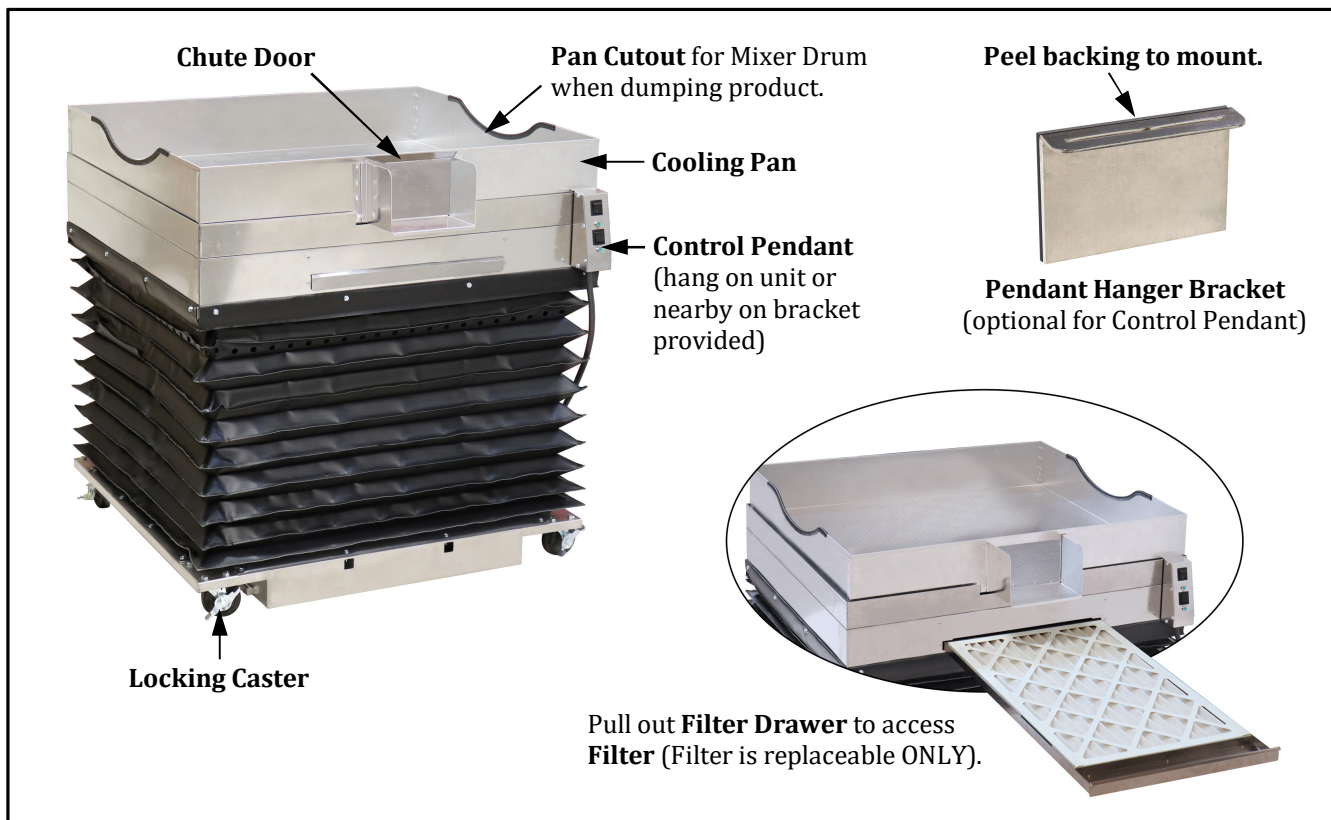

1. Remove all packaging and tape prior to operation.
2. The unit is equipped with 4 rolling Casters with locking/unlocking feature; position unit for use on a level surface, and lock casters into place.
3. The hand control is equipped with a hanging clip and magnets for holding the control on the unit. An adhesive back Pendant Hanger is also provided to hang the Control Pendant near the unit, if desired. (Make sure the mounting location is clean and dry, then remove adhesive backing paper, and firmly press bracket to surface).
4. The unit has an efficient filtration system, pull out the Filter Drawer to access the Filter (16" x 25" x 1"). The filter is replaceable only (reference cleaning section for replacement instructions).
5. Make sure the Cooling Pan is setting flat on the blower unit for use, and the Chute Door is in place.
6. By default, the Control Pendant is on the right hand side of the unit. If needed the control may be routed out the opposite side of the unit (reference the Maintenance section for instructions on re-routing the cord).
7. After setup, the unit should be cleaned prior to use (see Care and Cleaning section).



## Electrical Requirements

The following power supply must be provided (reference unit Data Plate for Wattage requirement):

**120 V~, 60 Hz**

	 <b>DANGER</b>
	<p>Machine must be properly grounded to prevent electrical shock to personnel. Failure to do so could result in serious injury, or death.  <b>DO NOT</b> immerse any part of this equipment in water.  <b>DO NOT</b> use excessive water when cleaning.            Keep cord and plug off the ground and away from moisture.            Always unplug the equipment before cleaning or servicing.            Make sure all machine switches are in the OFF position before plugging the equipment into the receptacle.</p> <p style="text-align: right; font-size: small;">008_051514</p>

A certified electrician must furnish sufficient power for proper machine operation and install any supplied receptacle (reference unit Data Plate for model specific Volts AC, Hertz, and Wattage requirements). We recommend this equipment be on a dedicated and protected circuit. Failure to wire properly will void the warranty and may result in damage to the machine. It is Gold Medal Products Co.'s recommendation that this machine be plugged directly into a wall outlet. The use of extension cords is not recommended due to safety concerns, and may cause sacrificed and/or reduced performance. Make sure cord is located to prevent a trip hazard or unit upset. Units with an IEC Power Cord - make sure the IEC cord is properly seated into the IEC receptacle before powering up the machine.

## Before You Plug In Machine

1. Make sure all machine switches are OFF before plugging equipment into receptacle.
2. Make sure wall outlet can accept the grounded plugs (where applicable) on the power supply cord.
3. The wall outlet must have the proper polarity. If in doubt, have a competent electrician inspect the outlet and correct if necessary.
4. **DO NOT** use a grounded to un-grounded receptacle adapter (where applicable).
5. Install unit in a level position.

	 <b>CAUTION</b>
	<p>If the supply cord is damaged, it must be replaced by Gold Medal Products Co., its service agent or similarly qualified persons in order to avoid a hazard.</p> <p style="text-align: right; font-size: small;">039_080614</p>



# OPERATING INSTRUCTIONS

## Controls and Their Functions

### POWER SWITCH

Two position, ON/OFF lighted rocker switch – provides power to blowers and to the Lift Momentary Switch.

### LIFT MOMENTARY SWITCH (and Indicator Lights)

Momentary switch – press and hold switch in the UP or DOWN position to raise or lower the table (the UP or DOWN Indicator will light accordingly).

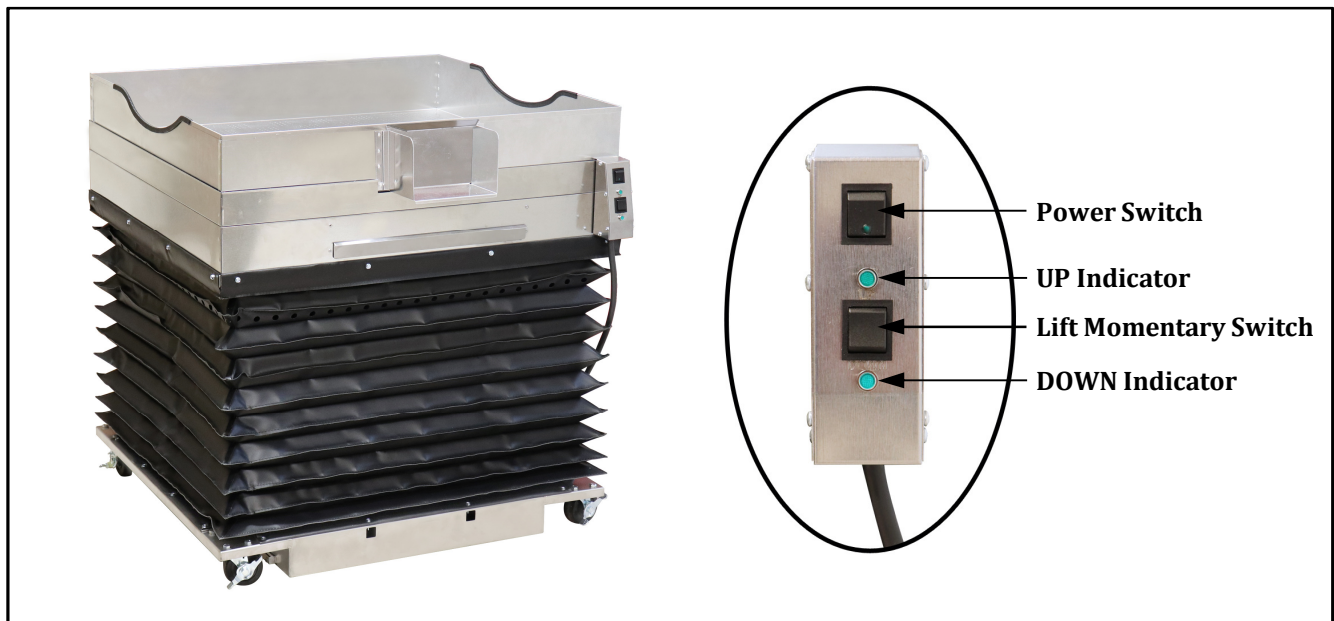



## Operating Instructions

This unit is designed for use with a Gold Medal 5 gallon or 10 gallon Corn Treat Mixer.

1. Turn Power Switch ON when ready to make a batch of caramel corn (the cooling fans will start).
2. Hold Momentary Switch to put the unit in the **lowest position** for cooking, mixing, and dumping caramel corn.
3. Once product is dumped onto the Karmel Kool Table, raise the table to the desired position to mix/separate the caramel corn using two popcorn scoops.
4. Gently move the corn around the pan until cooled and separated, then remove the corn for the next batch.



## Care and Cleaning

	 <b>DANGER</b>
	Machine must be properly grounded to prevent electrical shock to personnel. <b>DO NOT immerse in water.</b> DO NOT clean appliance with a water jet. Always unplug the equipment before cleaning or servicing. <span style="float: right;">025_111616</span>

Good sanitation practice demands that all food preparation equipment be cleaned regularly (only use non-toxic, food grade cleaners). A clean looking, well-kept machine is one of the best ways of advertising your product.

For surfaces needing further cleaning or degreasing, Watchdog Stainless Cleaner (Item No. 2088) or Watchdog Concession Equipment Degreaser (Item No. 2580) is available for use accordingly. For any cleaning products used, follow the manufacturer's instructions on the product. **DO NOT use oven cleaners or abrasive materials** as they will damage parts of machine.

Follow the directions below to clean the unit each day after use.

1. Put machine in highest position, then turn machine OFF and unplug it to clean.
2. Remove any remaining popcorn.
3. Lift cooling pan off unit and clean all pans/accessories - take them to the sink to clean with soap and water, then rinse and dry.
4. Clean under corn pan to remove any debris with a vacuum as needed (wipe area clean with a clean dry cloth as needed).
5. Clean outside of unit with a soft cloth, slightly dampened with soap and water, then wipe again with a clean damp cloth to remove any remaining cleaner. Allow bellows to dry completely before lowering the unit.

### Filter Cleaning Instructions

The unit is equipped with an efficient and durable filtration system. The filter is replaceable only, it should be changed monthly with heavy use, or as needed depending on environment conditions.

1. Pull out the filter drawer far enough to check/replace the filter (**air flow direction for the filter must go UP**).
2. Reinsert drawer fully for use. DO NOT operate the unit without the filter in place.



# MAINTENANCE INSTRUCTIONS

	<b>⚠ DANGER</b>
	<p>Machine must be properly grounded to prevent electrical shock to personnel. Failure to do so could result in serious injury, or death. DO NOT immerse any part of this equipment in water. DO NOT use excessive water when cleaning. Keep cord and plug off the ground and away from moisture. Always unplug the equipment before cleaning or servicing. Make sure all machine switches are in the OFF position before plugging the equipment into the receptacle.</p> <p>008_051514</p>

	<b>⚠ DANGER</b>
	<p>Improper installation, adjustment, alteration, service, or maintenance can cause property damage, injury, or death. Any alterations to this equipment will void the warranty and may cause a dangerous condition. This appliance is not intended to be operated by means of an external timer or separate remote-control system. NEVER make alterations to this equipment. Read the Installation, Operating, and Maintenance Instructions thoroughly before installing, servicing, or operating this equipment.</p> <p>014_020416</p>

	<b>⚠ WARNING</b>
	<p>No user serviceable parts inside. Refer servicing to qualified service personnel.</p> <p>011_051514</p>

	<b>⚠ CAUTION</b>
	<p>THE FOLLOWING SECTIONS OF THIS MANUAL ARE INTENDED ONLY FOR QUALIFIED SERVICE PERSONNEL WHO ARE FAMILIAR WITH ELECTRICAL EQUIPMENT. THESE ARE NOT INTENDED FOR THE OPERATOR.</p> <p>027_010914</p>



# Safety Stop Bracket

Unit is equipped with a Safety Lock Bracket for use when servicing the lift mechanism.

1. Raise the table to the highest position, then turn the unit OFF and unplug it.
2. Remove the (16) 10-24 lock nuts fastening the safety bellows to the base frame.
3. Lift the bellows (bellows may be held up with zip ties for easy access to unit interior).
4. By default, the Safety Stop Bracket is DISENGAGED to allow the lift to be raised and lowered. To ENGAGE the Safety Stop Bracket, loosen the 2 thumb screws and push the bracket up against the axle to hold it in place, then re-tighten the thumb screws. Reference the images below for correct bracket positioning.
5. The Safety Stop Bracket MUST be DISENGAGED prior to operation, then lower the bellows and reinstall all fasteners to secure it to the frame. (If bellows are not lowered, damage to the machine may occur.)

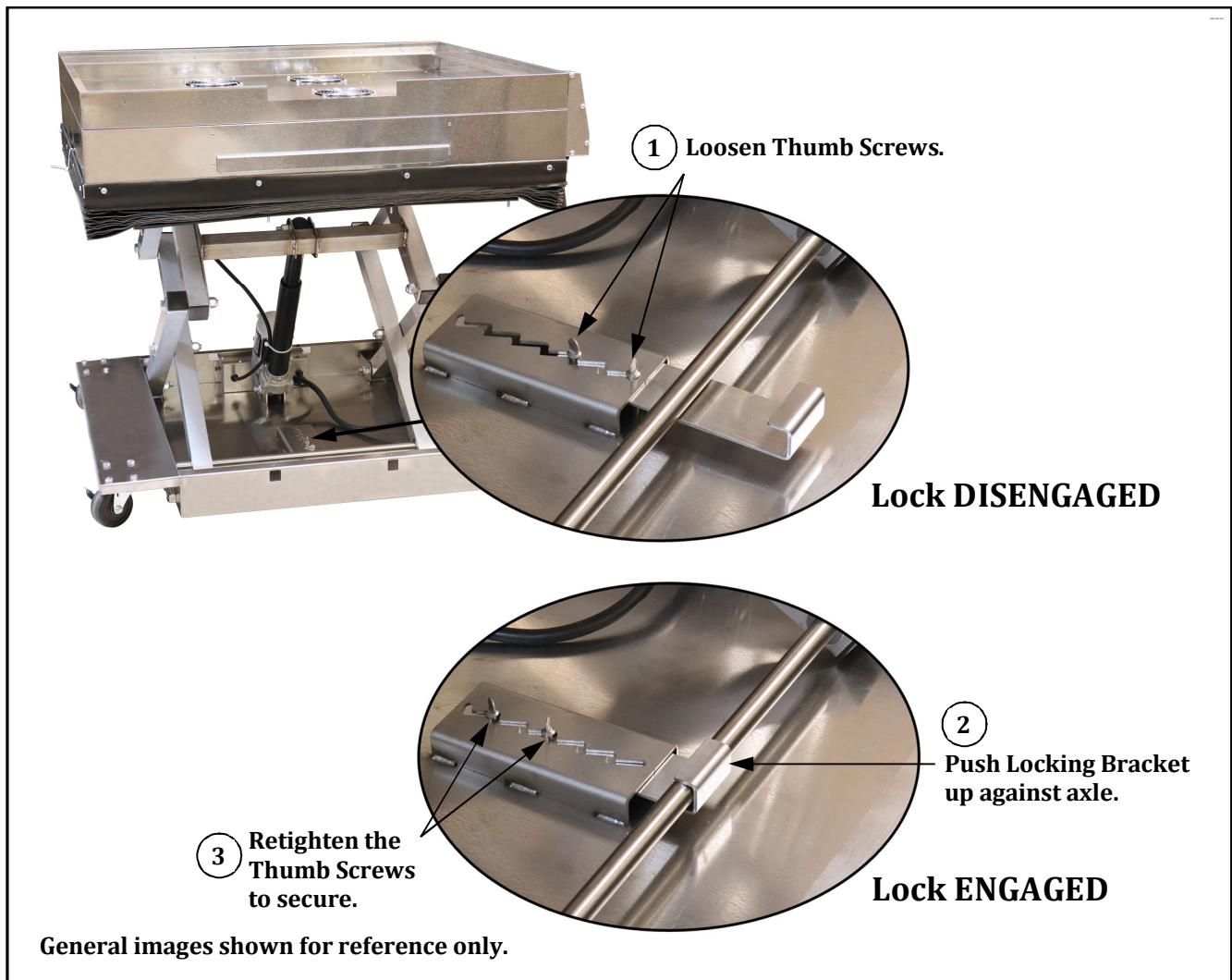



## Control Pendant Orientation

Depending on the placement of the table, the Control may need to be located on the opposite side of the unit. Follow the instructions below to re-route the cord out the opposite side of the unit (reference the images shown).

1. Raise the table to the highest position, then turn unit OFF and unplug it before switching the control to the opposite side of the table.
2. Remove the (16) 10-24 lock nuts fastening the safety bellows to the base frame.
3. Lift the bellows (bellows may be held up with zip ties for easy access to unit interior).
4. Remove the 2 screws and 2 nuts holding the control cord plate to the frame. Pull the cord and control pendant through the frame opening, then re-route it through the opening on the opposite side, and reinstall fasteners to secure cord plate to frame.
5. Lower the bellows and reinstall all fasteners to secure it to the frame.

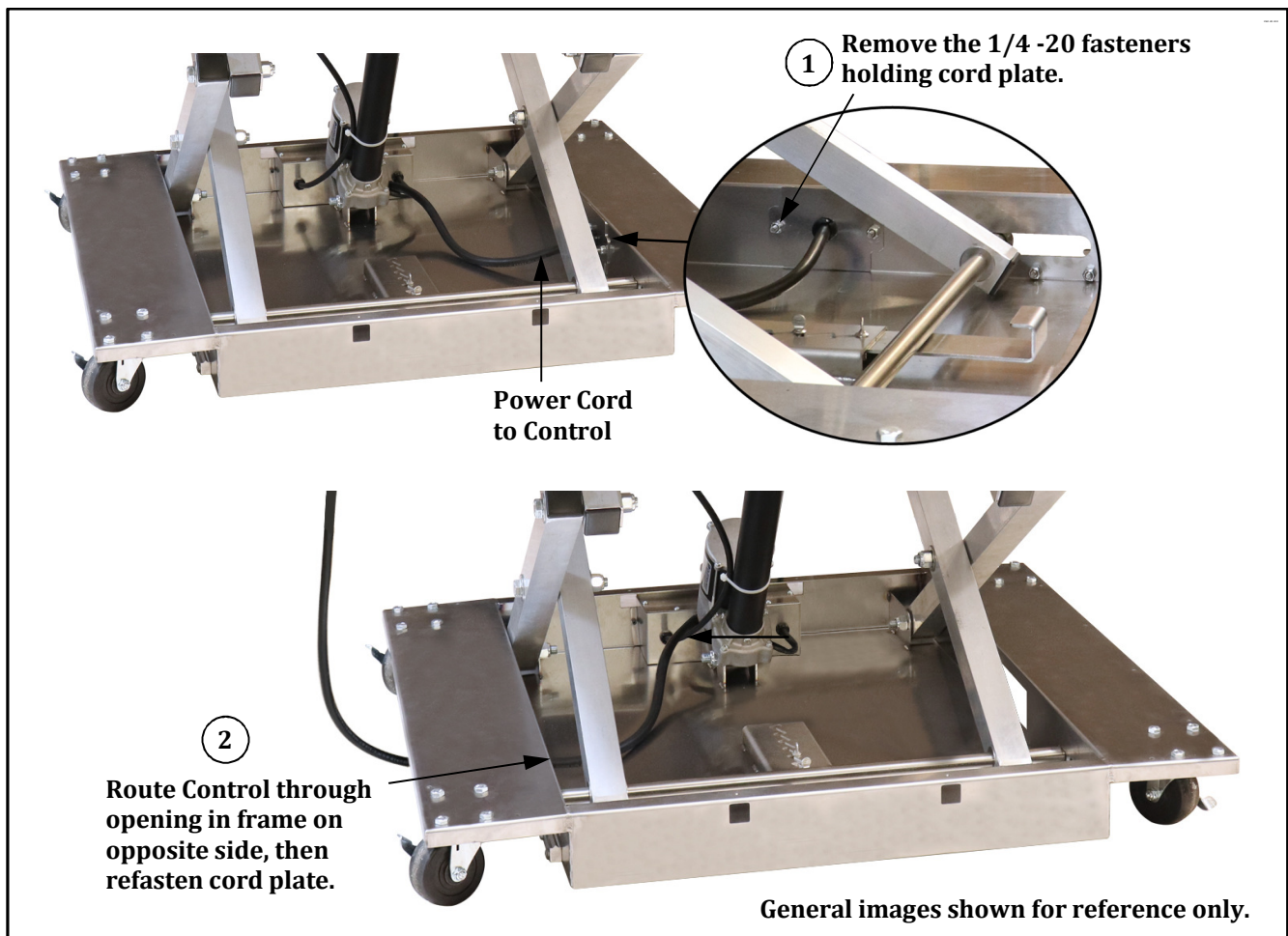



---

## ORDERING SPARE PARTS

1. Identify the needed part by checking it against the photos, illustrations, and/or parts list. (General images may be used in manual for reference only.)
2. Use only approved replacement parts when servicing this unit.
3. When ordering, please include part number, part name, and quantity needed.
4. Please include your model number, serial number, and date of manufacture (located on the machine nameplate/data plate) with your order.
5. Address all parts orders to Parts Department, Gold Medal Products Co., 10700 Medallion Drive, Cincinnati, Ohio 45241-4807

or place orders by phone or online:

Phone: (800) 543-0862  
(513) 769-7676

Fax: (800) 542-1496  
(513) 769-8500

E-mail: [info@gmpopcorn.com](mailto:info@gmpopcorn.com)  
Web Page: [gmpopcorn.com](http://gmpopcorn.com)





# Unit Exterior – Parts Breakdown

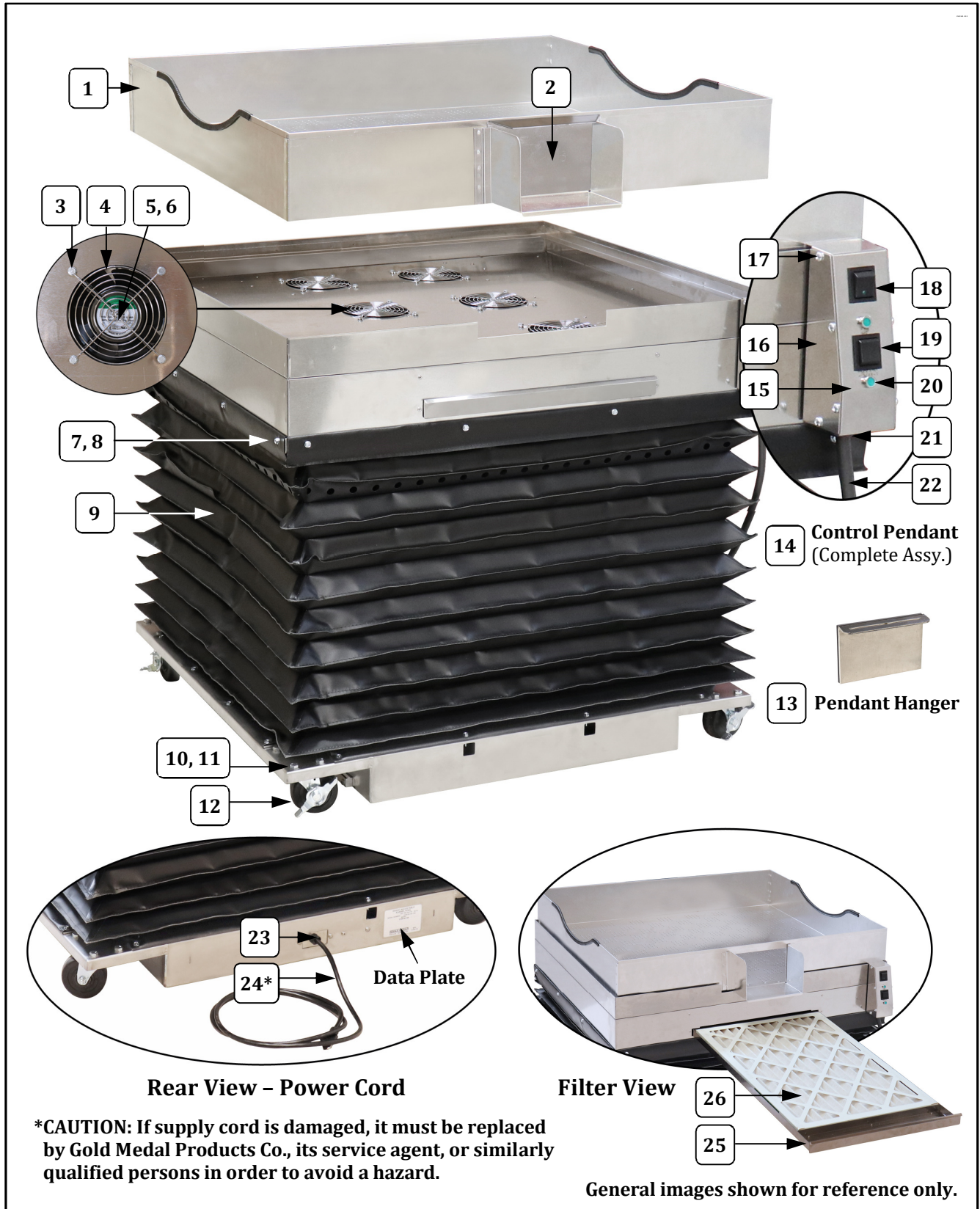

Rear View - Power Cord

Filter View

**\*CAUTION:** If supply cord is damaged, it must be replaced by Gold Medal Products Co., its service agent, or similarly qualified persons in order to avoid a hazard.

General images shown for reference only.



## Unit Exterior – Parts List

Item	Part Description	Part Number
		2169-00-100
1	COOLING PAN ASSEMBLY 2169	101448
2	DOOR COOLING PAN CHUTE	46344
3	SCREW, 10-24 X 3/4 HXHD	41314
4	5IN FAN GRATE	74783
5	EXHAUST BLOWER 120V,60CY	48018
6	EXHST BLOWER PLUG & CORD	47199
7	10-24 x 3/4 SERRATED HEX (fastens bellows)	76653
8	HEX NUT #10-24 ESLOK (fastens bellows)	74691
9	BLK SCISSOR TABLE BELLOWS	101393
10	5/16-18 X 1/2 HHC GRADE 2	47206
11	5/16-18 SERRATED LOCK NUT	49317
12	NSF SWIVEL CSTR W/LOCK	37514
13	OP PENDANT HANGER ASSY	101442
14	OPERATOR PENDANT ASSEMBLY (complete assembly - includes hand control and cord)	101406
15	PENDANT FACE PLATE	101404
16	PENDANT OUTSIDE WRAP	101405
17	SCREW #8-32X3/8 PAN HD PH	74141
18	SWITCH, LIGHTED ROCKER GR	42798
19	3 POS MOM ROCKER SWITCH	101408
20	PILOT LIGHT, 125V GREEN	48660
21	STRAIN RELIEF SR-31-2	41735
22	PENDANT WIRE ASSEMBLY	101446
23	STRAIN RELIEF SR-6P3-4	76026
24*	POWER SUPPLY CORD 15 AMP	22038
25	FURNACE FILTER TRAY ASSY	101436
26	FURNACE FILTER 16X25X1	101426





# Unit Interior – Parts Breakdown

Bellows may be held up with zip ties for service.  
Bellows **MUST** be refastened to base for use.

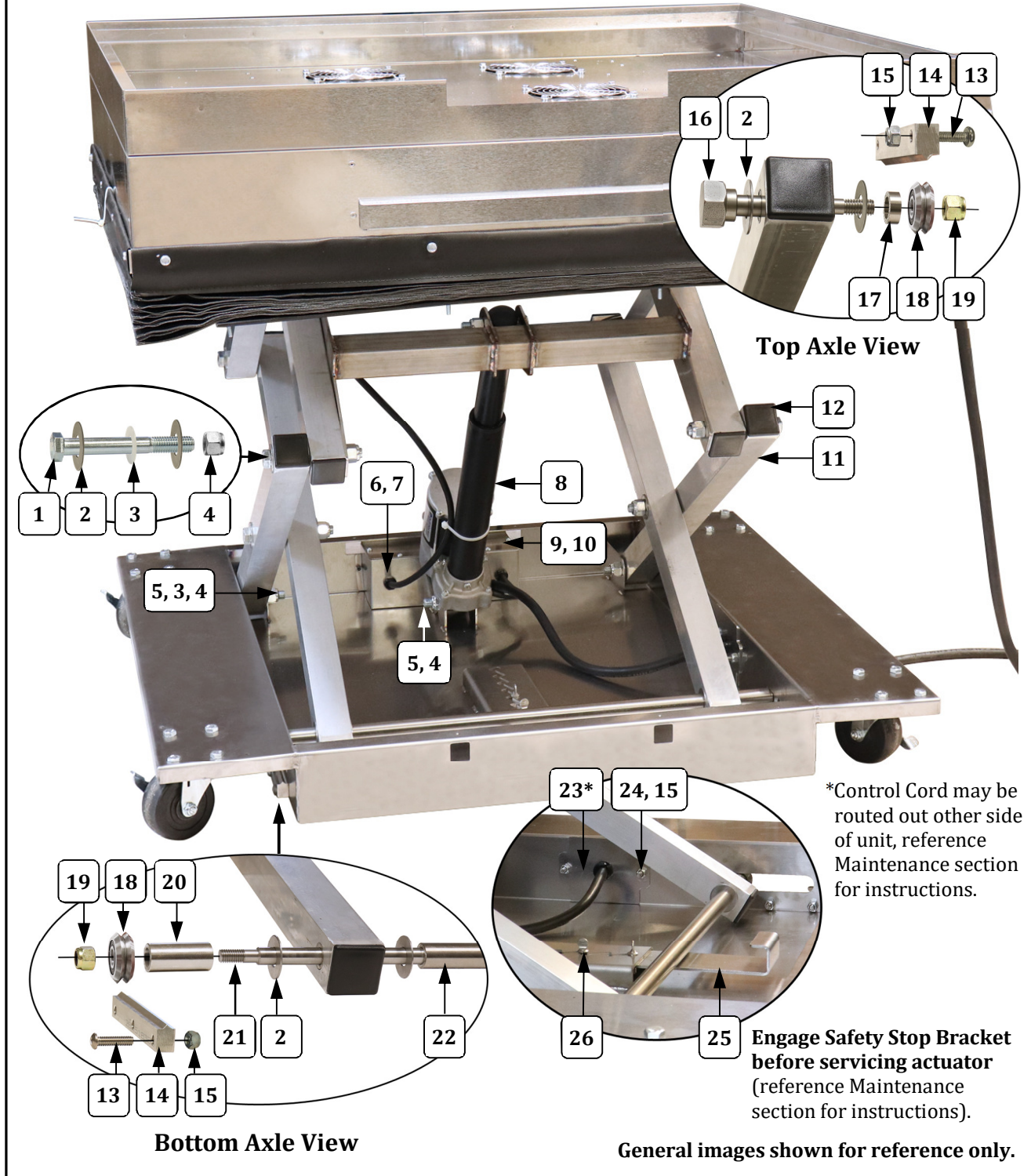



## Unit Interior – Parts List

Item	Part Description	Part Number
		2169-00-100
1	1/2-13 X 4 GRD 5 HHCS	101441
2	WASHER SS .5 ID X 1.10 OD	48428
3	NYLON THRUST WASH .500 ID	101400
4	1/2-13 GRADE 5 NYLOCK NUT	101439
5	1/2-13 X 2-3/4 GRD 5 HHCS	101440
6	STRAIN RELIEF SR-6P3-4	76026
7	FAN WIRE ASSEMBLY	101447
8	LINEAR DRIVE MACH 120VAC	101380
9	CONTROL BOX COVER	101403
10	SCREW #8-32X3/8 PAN HD PH	74141
11	SCISSOR LIFT BAR ASSEMBLY (includes square plug)	101383
12	SQUARE PLUG 1 1/2 X 1/8 W	69161
13	1/4-20X1" SS BUTTON HD	68530
14	V-GROOVE GUIDE RAIL	101391
15	HEX NUT 1/4-20 ESLOK	42361
16	TOP STUB AXLE	101433
17	UPPER AXLE SPACER SHORT	101409
18	V-GROOVE GUIDE BEARING	101392
19	3/8-16 NYLON LOCKNUT	114032
20	LOWER AXLE SPACER SHORT	101390
21	GUIDE AXLE	101389
22	LOWER SPACER BAR LONG	101384
23*	PENDANT STRAIN RELIEF PLT	101445
24	1/4-20x3/4 BUTTON HD SC	67927
25	SAFETY STOP SLD BRKT ASSY	101399
26	THUMB SCREW 1/4-20 X 3/4	38379



# Wiring Diagram

## Model No. 2169-00-100

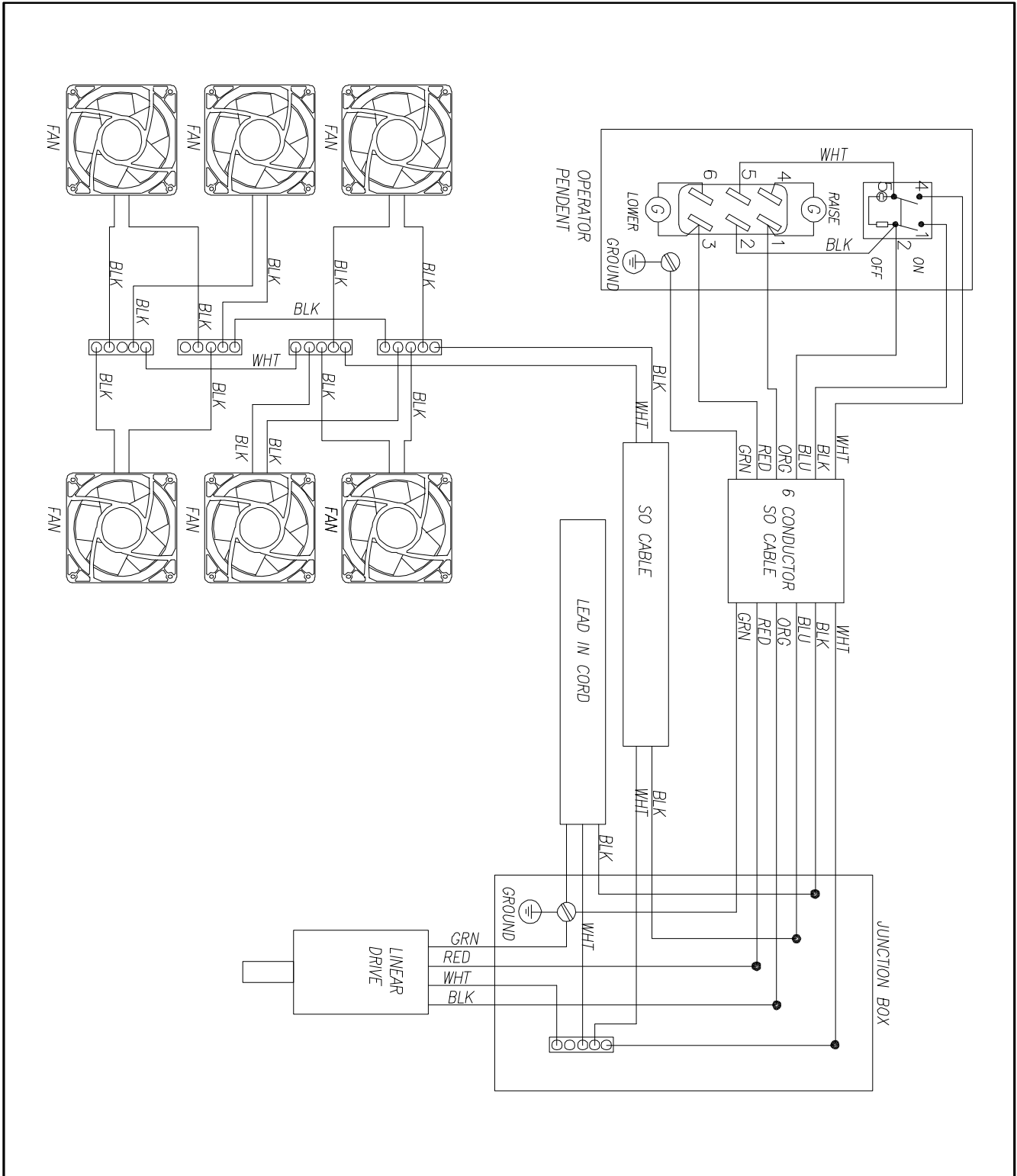



## WARRANTY

Gold Medal Products Co. warrants to the original purchaser each item of its manufacture to be free of defects in workmanship and material under normal use and service. Gold Medal Products Co.'s obligation under this warranty is limited solely to repairing or replacing parts, f.o.b. Cincinnati, Ohio, which in its judgment are defective in workmanship or material and which are returned, freight prepaid, to its Cincinnati, Ohio factory or other designated point. Except for "Perishable Parts" on specific machines, the above warranty applies for a period of two (2) years from the date of original sale to the original purchaser of equipment when recommended operating instructions and maintenance procedures have been followed. These are packed with the machine. Parts warranty is two (2) years, labor is six (6) months.

THIS WARRANTY IS IN LIEU OF ALL OTHER WARRANTIES EXPRESSED OR IMPLIED, AND OF ALL OTHER OBLIGATIONS OR LIABILITIES ON OUR PART, INCLUDING THE IMPLIED WARRANTY OF MERCHANTABILITY. THERE ARE NO WARRANTIES WHICH EXTEND BEYOND THE DESCRIPTION ON THE FACE HEREOF. In no event shall Gold Medal Products Co. be liable for special, incidental or consequential damages. No claim under this warranty will be honored if the equipment covered has been misused, neglected, damaged in transit, or has been tampered with or changed in any way. No claim under this warranty shall be honored in the event that components in the unit at the time of the claim were not supplied or approved by Gold Medal Products Co. This warranty is effective only when electrical items have been properly attached to city utility lines only at proper voltages. This warranty is not transferable without the written consent of Gold Medal Products Co.

The term "Original Purchaser" as used in this warranty shall be deemed to mean that person, firm, association, or corporation who was billed by the GOLD MEDAL PRODUCTS CO., or their authorized distributor for the equipment.

THIS WARRANTY HAS NO EFFECT AND IS VOID UNLESS THE ORIGINAL PURCHASER FIRST CALLS GOLD MEDAL PRODUCTS CO. AT 1-800-543-0862 TO DISCUSS WITH OUR SERVICE REPRESENTATIVE THE EQUIPMENT PROBLEM, AND, IF NECESSARY, FOR INSTRUCTIONS CONCERNING THE REPAIR OR REPLACEMENT OF PARTS.

*NOTE: This equipment is manufactured and sold for commercial use only.*



**GOLD MEDAL<sup>®</sup> PRODUCTS CO.**

10700 Medallion Drive, Cincinnati, Ohio 45241-4807 USA

[gmpopcorn.com](http://gmpopcorn.com)

Phone: (800) 543-0862      Fax: (800) 542-1496  
(513) 769-7676              (513) 769-8500